

Riktlinjer för fönstermarkis i Brf Flädern, Tygelsjö

Godkänd fönstermarkis: Vertikalmarkis

Ralfärg: För boende i gavelhus, ljust tegel gäller **RAL 9006** ljusgrå.

För boende i mitten, mörkt tegel , gäller **FSM 71319** antracit.

Vävfärg: Mörkgrå/Antracit

Förslag från Bellevue solskydd på vertikalmarkis:

Harol - SC 800 zip screen, se produktblad nedan.

Harol - Coolscreen 8 Solar, se produktblad nedan.

Det går bra att anlita valfri leverantör av fönstermarkis så länge ovan krav uppfylls.

Leverantörsoffert samt produktblad skickas till styrelsen för godkännande innan inköp.

1. Åtgärdsöverenskommelse skrivs under mellan styrelse och medlemmar.
2. Entreprenaden som utför arbete skall vara godkänd för F-skatt.
3. Entreprenaden skall vara försäkrad som innefattar allrisk och ansvar. Medlemmar kontrollerar detta genom att be om försäkringsbevis.
4. Entreprenad skall lämna garanti på utförandet (inte material) för minst 2 år.
5. Installationen och ingrepp på husfasad och inuti vägg skall göras fackmannamässigt.
6. Ingrepp på fasad skall återställas till fullo vid bortmontering.

SC800-ZIP

Vindbeständig
skuggmästare



Till
39 m/sec.*

ENERGISNÅL OCH STADIG

Med sin vindklass 6 har en SC800-ZIP utvändigt screen inga problem med kraftiga vindstötter. Goda nyheter för passivbyggare: byggnadsskalet behöver inte brytas, fastighetens isolering förblir alltså intakt. Duken är ännu efter många år rynkfri och av oklanderlig kvalitet. Allt tack vare dukens anti-slitageteknologi och vårt snillrika ZIP-system. Screenen skyddar dessutom mot insekter, de spar energi då kallras kan minskas och förbättrar inomhusklimatet under värmetoppar.

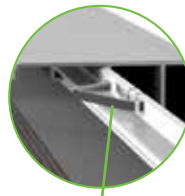

Suveränt rostfri
stålfjäder

**Duken hålls stram
längre tack vare
ZIP-systemet.**

Unikt hos detta förnyande system är den dolda, rostfria stålfjädern i sidoskenorna. Fjädern slits inte. Systemet är oerhört vindbeständigt, upp till 39m/sec.

Unika egenskaper

- 1 Perfekt för passivbygge: ingen öppning i byggnadsskalet
- 2 Idealisk för renovering och nybygge
- 3 Design: val mellan 2 kassetmodeller (modern - klassisk)

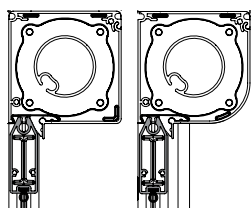

- 4 Väven håller längre tack vare den unika Xglide-teknologin

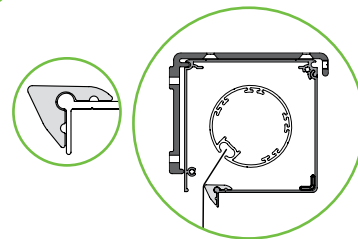

- 5 Strama dukar under längre tid tack vare förnyande Zip-system med stålfjäder och kan samtidigt fungera som ett skydd mot insekter.
- 6 Vindklass 6 vindmotstånd

* Testresultat enligt WTCB går vid konstant tryck till 1000 Pa "> 39 m/sec." och ett genomsnittsmått på 3,5 x 3 m.

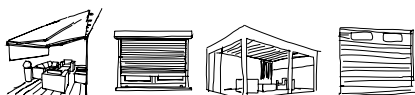

Kassett som passar din stil

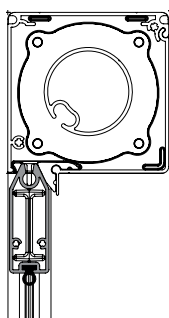

Rak kassett

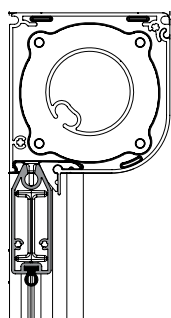

Rundad kassett

Den perfekta sidoskenan för varje situation

type 829

type 820

type 827

type 828

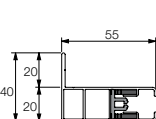
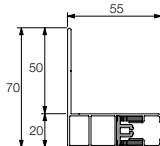
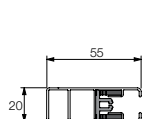
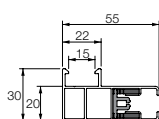

type 855

type 856

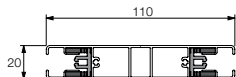
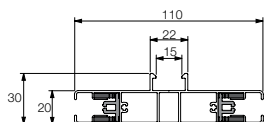

Kontroll

Elektrisk kontroll (standard)
Trådlöst: RTS och IO (tillval)

Vävens egenskaper

	Soltis Horizon 86	Soltis Perform 92	Soltis Opaque B92	Serge 600	Serge 1%	Serge 600 Lunar
Vikt ca. (g/m ²)	380	420	650	525	638	678
Tjocklek ca. (mm)	0,43	0,45	0,6	0,74	0,78	0,73
Genomsläppning av direkt solstrålning	14%	8%	0%	5%	1%	0%
G-totalvärdet (*)	0.15 - 0.22	0.05 - 0.15	0.02 - 0.05	0.01 - 0.10	0.05 - 0.09	0.02 - 0.09

*Glas C U=1,2

Rätt kassett för varje screen

Kassetterns storlek bestäms av screenens mått samt typ av screenväv.

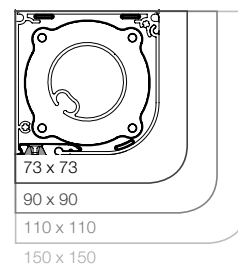
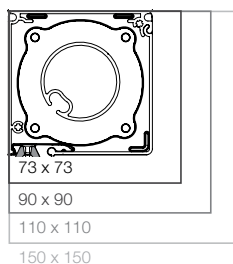

Rätt väv för ett perfekt resultat

- Visuell komfort
- Transparent eller mörkläggande
- Termiskt & akustiskt isolerande
- Mycket hållbar
- Smutsfrånstötande och brandskyddad
- Perfekt i harmoni med din bostad



Ge din screenväv en egen accent!

Sätt din egen logotyp eller design på dina dukar, vi trycker logon efter dina önskemål.

Profiler anpassade till husets kulör

Alla RAL-färger och ett brett sortiment strukturlackfärger mot standardpris

K-7 RAL-prover



Alla våra HAROL-produkter står för:



Veta mer? Gå till www.harol.com

DIN HAROL ÅTERFÖRSÄLJARE



HAROL®

SOLSKYDD • UTELIV • RULLPORTAR • GARAGEPORTAR

HAROL

WE BELIEVE IN NATURAL COOLING



Coolscreen Solar

Coolscreen 8 Solar, sustainable cooling thanks to the sun

Discover our latest innovation in the screens range: Coolscreen 8 Solar, a compact sun protection screen that runs on solar energy. The Coolscreen 8 Solar stands for premium quality and classy design, ready to cool any building the natural way to the max. Good for your health, the environment and your energy bills. Harol Coolscreen 8 Solar operates completely autonomously all year round. The powerful battery has a large storage capacity and is integrated into the box as standard, maintaining its sleek character. Coolscreen 8 Solar fits onto existing windows as well as being the perfect solution for new build projects without structural intrusions. Enjoy the ultimate in comfort, thanks to the sun!



Unrivalled sustainable design

Coolscreen 8 Solar comes with a stylish, cubist box which is available in 2 sizes, depending on the dimensions of the window. In addition, the screen is an ingenious and screwless snap-fit design which only requires a minimal number of parts. A paragon of sustainable design.

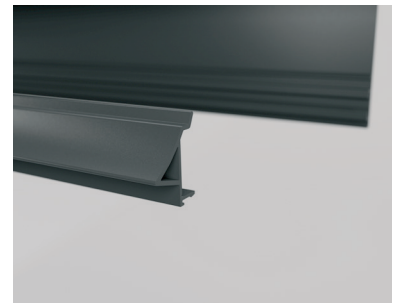

100% green solar energy

The Coolscreen 8 Solar runs on 100% green solar energy thanks to the very sleek and aesthetically pleasing solar panel and the powerful associated 2.2 Ah battery. Even facing north, a single solar panel* is all you need. So even on a less sunny day, your screen keeps working courtesy of the energy stored in the battery. What's more, you get a 7-year warranty on the motor, the battery and the solar panel.

Ultra-taut fabrics

Harol perfected the zip guide profile which consists of a polymer coextrusion which makes the profile resistant to extreme temperatures and continues to work to optimum effect at all times. The zip guide profile ensures the fabric is perfectly taut across the entire length. The sleek bottom lath has been weighted so the fabric remains perfectly taut even in horizontal position.

Silent operation

Coolscreen 8 Solar comes with noiseless operation thanks to the optimised X-glide technology, a profile that cancels out the resonance inside the box.

* The Somfy Solar application easily allows the fitter to create a tailored diagnostic report to calculate the performance of the Coolscreen 8 Solar for the installation.

Natural cooling thanks to Coolscreen 8 Solar

- ▶ 100% solar power, 1 unobtrusive solar panel
- ▶ Powerful 2.2 Ah battery, works all year round
- ▶ Minimalist, screwless design
- ▶ Ultra-taut fabrics, silent operation
- ▶ Window areas up to 12 m²
- ▶ Quick installation without structural intrusions
- ▶ Compact 90 mm or 110 mm box that perfectly fits inside the window opening

Available fabrics and technical features

	Serge Ferrari			Copaco		
	Soltis Horizon 86	Soltis Perform 92	Soltis Opaque B92	Serge 600	Serge 1%	Serge Blockout Lunar
Type	Polyester	Polyester	Polyester	Glass fibre	Glass fibre	Glass fibre
Approx. weight (g/m ²)	380	420	650	535	620	660
Approx. thickness (mm)	0.43	0.45	0.60	0.55	0.80	0.78
Transmission of direct sunlight	14%	3%	0%	5%	1%	0%
Solar transmission factor G _{tot} values**	0.12 - 0.22	0.05 - 0.16	0.01 - 0.05	0.08 - 0.12	0.06 - 0.09	0.02 - 0.05

** The lower the g-value, the higher the thermal insulation.

Premium quality

Aesthetic perfection, technical ingenuity.

Installation

- ▶ The installation of the Harol Coolscreen 8 Solar does not require any structural instructions or electrical work. It is fitted entirely on the outside of the home. This makes the screen perfectly suited for renovation and passive build projects.
- ▶ So much so you do not even need a power socket. All of which means the screen is easy to fit into place, even if you are not home.

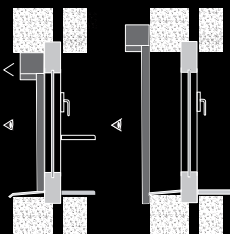

Technical ingenuity

- ▶ The innovative motor bracket and Cable Control Technology ensure faster and more efficient installation and after-service.
- ▶ Harol Coolscreen 8 Solar features Somfy's latest-generation io control as standard. This ultra-efficient screen motor works day and night and in all weather conditions. The motor features an integrated Somfy io-homecontrol receiver.
- ▶ Wide choice of high-tech fabrics that provide optimum sun protection and guarantee visibility to the outside according to the user's needs.

Design

- ▶ Minimalist rectangular box made from extruded aluminium.
- ▶ One snap-on guide rail in one compact 35 mm size which can be used for various installation applications.

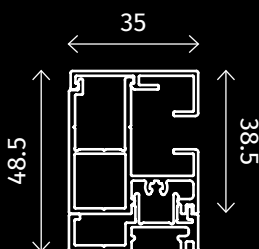

- ▶ Box comes in 2 sizes: 90 x 123 mm and 110 x 143 mm. The 90 mm box perfectly fits into the window opening, making it seamlessly blend with the facade.

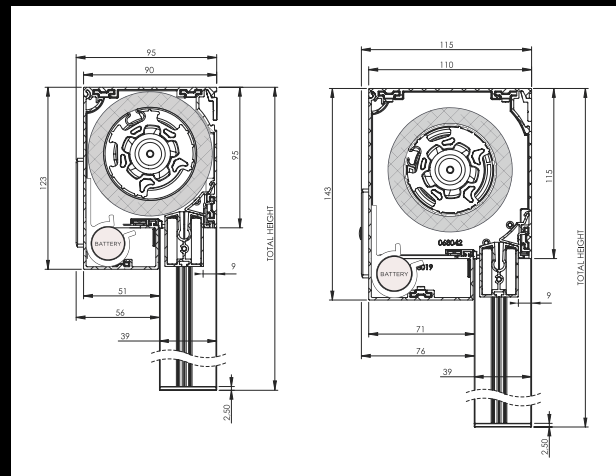

- ▶ Narrow 37 mm bottom lath which cleverly hides the weld seam and goes completely inside the box when closed.
- ▶ Aesthetic perfection thanks to screwless design of the box as well as the guide.

Sustainable

- ▶ Durable quality system tested at 15 000 cycles = 27 years of being opened and closed once a day.
- ▶ Complies with European standard EN13561: wind class 3.
- ▶ 100% green power. When fully charged, the screen will open and close twice a day for 30 days.
- ▶ Box and components are powder coated in our own eco-friendly paint shop.
- ▶ All of Harol's production processes are 100% powered by green wind energy.
- ▶ Minimal number of parts for a maximum of applications.
- ▶ Fully snap-fit design for efficient end-of-life recycling.

Servicing

- ▶ The box and profiles need to be cleaned on a regular basis using tepid water and a mild detergent, then rinsed thoroughly with tap water. Do not use corrosive or aggressive products, scouring pads or other abrasives.
- ▶ The closed box ensures the fabric is fully protected against dirt and soiling.

Coolscreen 8 Solar



STRUCTURE / DESIGN

Type	Surface-mounted
Max. width	4 m
Max. height	3 m
Max. surface area	12 m ²
Box	Rectangular
Box dimensions	90 x 123 mm 110 x 143 mm

CONTROLS

IO motor	Standard
RTS motor	Optional
Wired	N/A
Manual (winch handle)	N/A

WIND RESISTANCE

Beaufort	Up to Beaufort level 6
----------	------------------------

OPTIONS

Sun and wind sensor	Optional
---------------------	----------

SUSTAINABILITY

X-glide anti-wear fabric technology	Standard
Tested at 15,000 cycles	Standard



Applications

Hospitality venues, hotels, homes, flats, residential care homes, etc.



Warranty

Extended 7-year warranty terms on the battery and solar panel. 5-year warranty on all other parts.



Controls

Harol Coolscreen 8 Solar comes standard with an io control which can be connected to the io homecontrol system for home automation.

io-homecontrol.com



Harol reserves the right to make technical changes to the products detailed above.

 harolworldwide
 harolworldwide

 company/harol-consyst-nv
 +32 (0)13 38 01 11

Industrieterrein 1/3, Industriezone
 Webbekom 1025, 3290 Diest, Belgium

HAROL
 WE BELIEVE IN NATURAL COOLING

harol.com